

# Fenner

## Resilient Couplings



**POWERTRAN**

*Dependable Power Transmission Accessories*

# RESILIENT COUPLINGS



Fenner Resilient Couplings give you a combination of advantages of high power rating of a gear coupling and flexibility of elastomer coupling. They are easy to install and simple to maintain. The flexible grids are quickly replaceable without disturbing the connected equipment.

Fenner Resilient Couplings are available in broad range of sizes covering from 0.45 kW to 1307 kW per 100 rpm and bores upto 267mm.

## FEATURES :

- All metal construction having no fast wearing out components.
- Accurately machined. Dynamic balancing is normally not required.
- Torsionally flexible. Progressive torsional flexibility (due to curved profile) provides protection against shock load, impact load and vibration.
- Heat treated spring steel grid absorbs high impact shocks without loss of energy.
- Transmits full torque with dampened vibration and reduce peak loads.
- When over load occurs, grid fails and prevents failure of the Shaft or machinery part connected to the coupling.
- When parallel misalignment is too severe, the related machine is protected by the virtue of shearing of Grid or Tooth.
- Extended life of parts of machines (Mechanical seal and Bearing etc.)
- Easy to install.



## AVAILABLE IN TWO VARIANTS :

- **Horizontally split covers** : Easy access to grid. Ideal where space is tight.
- **Vertically split covers** : Ideal for higher running speeds

## SIMPLE AND EASY MAINTENANCE :

Fewer and less complicated components facilitate easy maintenance.

## CONSTRUCTION :

A High torque Resilient Coupling basically comprises a grid spring which connects two hubs one on the driving and the other on the driven shafts through axially cut grooves around the peripheries of the two hubs. The spring, which is of special design compatible to the required characteristics of the system, form a series of resilient bridges along the grooves. The grooves are flared to allow the grid members long flexible spans under normal loads as well as better support by the sides of the grooves under over load conditions.

The stiffness of the spring and thus the coupling depends on the length of each flexible span not in contact with the grooves. Subsequently, the contact length changes with every variation in torque, resulting in change in the stiffness of the coupling at every instant during a vibration cycle. Consequently this produces a powerful detuning action resulting in continuous alteration of the torsional vibration frequency and prevention of a build up of resonance in the system.

The principle of design adopted in Resilient Coupling, makes it capable to accommodate considerable axial, parallel and angular misalignment between a driving machine and a driven machine. Simultaneously, it can absorb considerable overloads due to high torque with consequent reduction in wear and tear on plants and machinery. With the use of resilient couplings, break-down and down time in any manufacturing unit, will be minimum.



# RESILIENT COUPLINGS



## BENEFITS :

### 1. Protection against shaft misalignment :

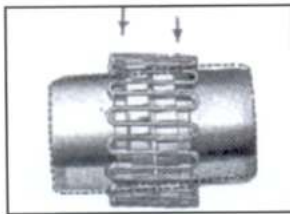

Parallel

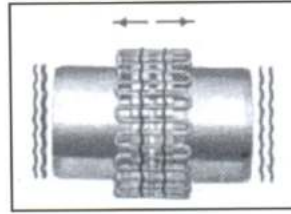

Axial

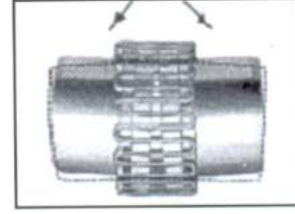

Angular

#### Parallel :

The movement of the grid in the grooves accommodates parallel misalignment and still permits full functioning of the grid-groove action in damping out shock and vibration.

#### Angular :

Under angular misalignment, the grid-groove design permits a rocking and sliding action of the grid and hubs without any loss of power through the resilient grid.

#### Axial :

End float for both driving and driven members is permitted because the grid slides freely in the grooves

### 2. Protection against Shock loads, Vibration & Thrust loads :

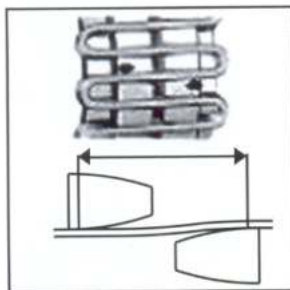

Light Load

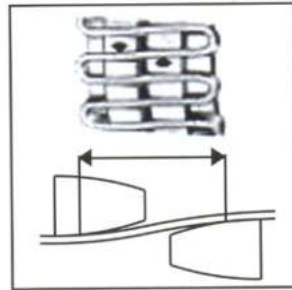

Normal Load

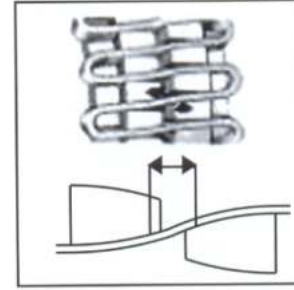

Shock Load

#### Light Load :

The grid bears near the outer edges of the hub teeth. The long span between the points of contact remains free to flex under load variations.

#### Normal Load :

As the load increases, the distance between the contact point & on the hub teeth is shortened, but a free span still remains to cushion shock loads.

#### Shock Load :

The coupling is flexible within its rated capacity. Under extreme over-loads, the grid bears fully on the hub teeth and transmits full load directly.

## APPLICATION :

Agitators	Conveyors	Haulages	Paper Mills	Punching Machines	Steam turbines
Alternators	Cranes	Machine Tools	Pulp Mills	Refrigerators	Textile Machinery
Ball Mills	Crushers	Mixers	Pulverisers	Rolling Mills	Traction tube Mills
Cement Mills	Fans	Motor Generators	Pumps	Rubber Machinery	Winders

# RESILIENT COUPLINGS



## DESIGNATION :



## GENERAL GUIDELINES FOR SELECTION OF COUPLING :

1. Determine service factor corresponding to the type of application under consideration from the Table of Service Factors.
2. Determine the maximum Horse Power :  $\text{Normal rated H.P} \times \text{Service Factor of Drive} \times \text{Service Factor of Prime Mover.}$
3. Determine Rating of coupling =  $\frac{\text{Maximum H.P.}}{\text{Rated R.P.M. of Drive}}$

After having determined the rating of coupling, select a coupling corresponding to the rating from the Tables of Types & Sizes, and simultaneously check whether maximum bore and recommended speed of the coupling correspond to the requirements of the drive. If the allowable maximum bore is too small, select a larger Coupling; in case allowable safe speed is too low, a different type of Coupling will have to be considered.

### EXAMPLE :

Required a coupling to connect a 20 H.P. / 980 R.P.M. Motor to a speed reducer driving an inclined assembly conveyor. Motor shaft diameter is 40mm and reducer shaft diameter is 38mm.

Service factor from Table	:	1
Prime Mover Factor	:	1
Required rating of Coupling	=	$\frac{20 \text{ H.P.} \times 1 \times 1}{980}$
	=	0.020 H.P./R.P.M.
Recommended Coupling size is		<b>"FRC 3"</b>

# RESILIENT COUPLINGS



## APPLICATION AND SERVICE FACTOR

Type of Applications	Factor	Type of applications	Factor
<b>Agitator</b>	2.0	<b>Machine Tools:</b>	
<b>Blower</b>	2.0	Main Drive	2.0
<b>Compressor, Centrifugal/rotary</b>	2.5	Auxiliary drive	1.5
		Traverse drive	1.5
<b>Conveyor</b>	1.0	Bending Roll ,Notching Press	
Apron, Belt, Chain	2.0	Punch Press, Planer, Plate-	
Bucket	3.0	Reversing	3.0
Live Roll, Shaker		<b>Mixers</b>	
		Concrete & Muller	2.5
<b>Cranes &amp; Hoist</b>		*Paper mill	1 to 5
Class 1&2:Hoists	3.0	<b>Fans</b>	
Bridge ,travel or Trolley	2.5	Cooling Tower & Mine	2.5
Class 3 & 4:Hoists	4.0	Industrial	2.0
Bridge, Travel or Trolley	3.0	<b>Pumps:</b>	
		Centrifugal-even load	1.3
<b>Crushers, Stones &amp; Ores</b>	4.0	under load	1.8
<b>Dynamometer</b>	2.0	Gear, Rotary or vane	2.0
<b>Elevators, Bucket</b>	2.5	Reciprocating- 1 or 2 cyl.	3.0
<b>Escalators</b>	2.0	3 or more cyl	2.5
<b>Extruder, Plastics / Rubber</b>	2.0		
<b>Feeders:</b>		<b>Rubber Industry:</b>	
Apron, Belt, Screw-Horizontal	1.0	Mixing Mill, Refiner	3.0
		Worming Mill	2.5
<b>Generators:</b>		Others	1.5 to 3
Even Load	1.7		
Hoist or Rly. Service	2.5	<b>Screens:</b>	
Welder Load	2.5	Rotary, Coal or Sand	2.0
<b>Hammer Mill, Cement or Mines</b>	2.5	Vibrating	3.5
<b>Haulage, Mining</b>	3.0	<b>*Steel Mills/Rolling Mills</b>	2 to 6
<b>Kiln, Rotary for cement, Mining</b>	3.0	<b>Stoker</b>	1.5
<b>Line Shaft</b>	2.0	<b>Turbo-Generator</b>	1.3
		<b>Winch, Maneuvering:</b>	
		Dredge, Marine	2.0
		<b>Wood working Machinery</b>	1.5

### PRIME MOVER FACTOR :

1. Motor or Turbine :	1	3. Gas or Oil Engine :	
2. Steam Engine/Water Turbine :	1.25	1 Or 3 Cylinder :	2.0
		2 Or 4 Cylinder :	1.5

Note : Transmitted Power at the Coupling should be multiplied by the Prime Mover Factors as above depending on the type of Prime Mover involved in the drive.

\* Factors for Paper and Steel Mill drives are for general guidance. As these drives are varied in nature exact factor is to be arrived at after considering individual drives. Please consult Fenner with drive details.



# RESILIENT COUPLINGS



## STANDARD COUPLINGS-TYPE Z & Y

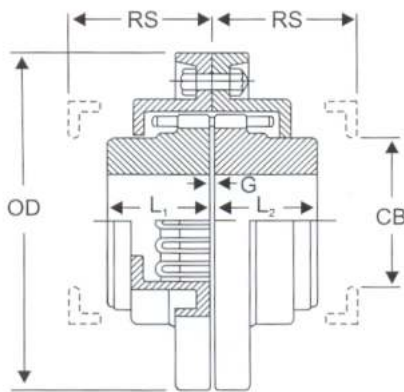

TYPE - Z  
SIZE :FRC-1 TO FRC-17

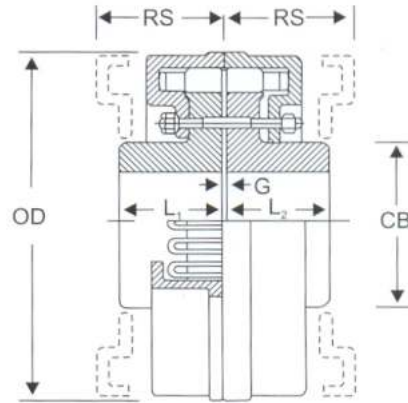

TYPE - Y  
SIZE :FRC-20 TO FRC-23

### TYPE - Z

( for use on horizontal shafts only )

Coupling Size	Rating H.P./RPM	Clear Diameter OD (mm)	Boss Length L1 (mm)	Boss Length L2 (mm)	Removal Space RS (mm)	Gap G (mm)	Cover Bore CB (mm)	Safe Speed R.P.M	Stock Rough Bore (mm)	Max. Bore (mm)	Approx. Weight Kgs
FRC-1	0.006	105.00	38.00	38.00	52.00	0.85	44.52	5650	10	29	3
FRC-2	0.010	120.50	38.00	38.00	52.00	0.85	58.80	4750	12	38	4
FRC-3	0.020	144.50	44.50	44.50	59.00	0.85	62.00	4450	16	41	5
FRC-4	0.030	171.50	51.00	51.00	59.00	0.85	87.45	3400	16	57	9
FRC-6	0.045	190.50	51.00	51.00	79.00	0.85	84.25	3200	16	54	11
FRC-7	0.065	197.00	57.00	57.00	79.00	0.85	96.95	2950	16	64	15
FRC-8	0.095	222.00	63.50	63.50	79.00	0.85	119.20	2500	25	78	20
FRC-9	0.125	254.00	70.00	70.00	80.00	0.85	143.00	2150	25	92	27
FRC-10	0.185	276.00	89.00	89.00	80.00	0.85	165.20	1900	25	108	43
FRC-11	0.355	295.00	102.00	102.00	128.00	1.60	155.70	1800	38	102	54
FRC-13	0.455	324.00	101.50	101.50	147.00	1.60	187.46	1650	50	123	63
FRC-14	0.655	336.50	101.50	101.50	147.00	1.60	184.28	1550	50	121	72
FRC-15	0.905	375.00	114.00	114.00	147.00	1.60	222.38	1350	50	146	104
FRC-17	1.255	425.50	127.00	127.00	147.00	1.60	254.00	1200	50	167	149

### TYPE - Y

( for use on horizontal shafts only )

Coupling Size	Rating H.P./RPM	Clear Diameter OD (mm)	Boss Length L1 (mm)	Boss Length L2 (mm)	Removal Space RS (mm)	Gap G (mm)	Cover Bore CB (mm)	Safe Speed R.P.M	Stock Rough Bore (mm)	Max. Bore (mm)	Approx. Weight Kgs
FRC-20	1.755	432.00	140.00	140.00	179.00	3.20	239.50	1200	75	157	175
FRC-21	2.405	432.00	140.00	140.00	179.00	3.20	239.50	1200	75	157	180
FRC-22	2.755	492.00	152.50	152.50	179.00	3.20	266.70	1100	85	173	207
FRC-23	3.505	492.00	152.50	152.50	179.00	3.20	266.70	1100	85	173	216

# RESILIENT COUPLINGS



## STANDARD COUPLINGS-TYPE X & S

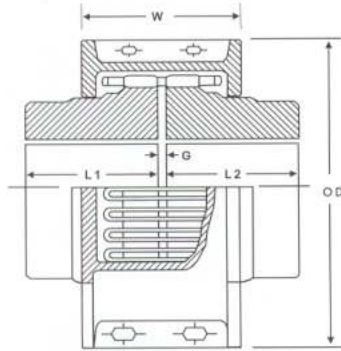

TYPE - X - AXIALLY SPLIT COVER  
SIZE :FRC-1 TO FRC-23

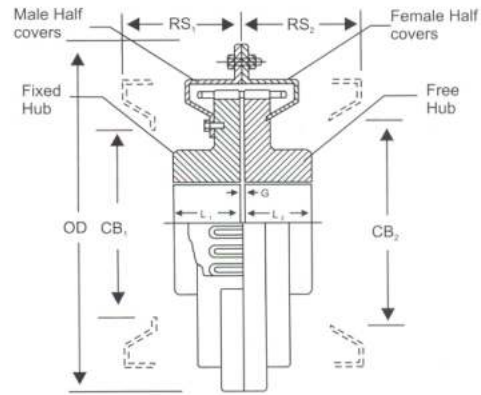

TYPE - S - VERTICAL SPLIT COVER  
SIZE :FRC-25 TO FRC-28

### TYPE - X

( for use on horizontal shafts only )

Coupling Size	Rating H.P./RPM	Clear Diameter OD (mm)	Boss Length L1 (mm)	Boss Length L2 (mm)	Cover Width W (mm)	Gap G (mm)	Safe Speed R.P.M	Stock Rough Bore (mm)	Max. Bore (mm)	Approx. Weight Kgs
FRC-1	0.006	104.00	38.00	38.00	57.00	0.85	3600	10	29	3.0
FRC-2	0.010	120.00	38.00	38.00	64.50	0.85	3350	12	38	4.0
FRC-3	0.020	127.00	44.50	44.50	64.50	0.85	3350	16	41	4.5
FRC-4	0.030	159.00	51.00	51.00	66.00	0.85	2575	16	57	7.5
FRC-6	0.045	178.00	51.00	51.00	84.50	0.85	2350	16	54	12.5
FRC-7	0.065	190.50	57.00	57.00	85.00	0.85	2150	16	64	16.5
FRC-8	0.095	222.50	63.50	63.50	86.50	0.85	1850	25	78	19.5
FRC-9	0.125	244.50	70.00	70.00	86.50	0.85	1650	25	92	27.0
FRC-10	0.185	267.00	89.00	89.00	86.50	0.85	1575	25	108	39.5
FRC-11	0.355	276.00	102.00	102.00	138.00	1.60	1450	38	102	47.5
FRC-13	0.455	324.00	101.50	101.50	157.00	1.60	1300	50	123	67.5
FRC-14	0.655	336.50	101.50	101.50	157.00	1.60	1250	50	121	74.0
FRC-15	0.905	381.00	114.00	114.00	159.00	1.60	1050	50	146	108.5
FRC-17	1.255	425.50	127.00	127.00	160.50	1.60	950	50	167	148.5
FRC-21	2.405	501.50	140.00	140.00	179.00	3.20	800	75	202	234.0
FRC-23	3.505	552.50	152.50	152.50	179.50	3.20	700	85	234	318.0

### TYPE - S

( for use on horizontal shafts only )

Coupling Size	Rating H.P./RPM	OD (mm)	Hub Length		Cover Bore		Removal Space		Gap G (mm)	Safe Speed R.P.M	Stock Rough Bore (mm)	Max. Bore (mm)	Approx. Weight Kgs
			L1 (mm)	L2 (mm)	CB1 (mm)	CB2 (mm)	RS1 (mm)	RS2 (mm)					
FRC-25	5.55	686.50	178.00	178.00	349.25	427.00	210.00	208.00	3.20	1200	110	191	408
FRC-26	7.55	781.00	203.00	203.00	432.50	511.00	210.00	208.00	3.20	1050	135	216	545
FRC-27	10.55	876.00	228.00	228.00	482.65	573.00	249.00	249.00	6.35	900	145	242	875
FRC-28	17.55	1015.00	228.00	228.00	622.30	711.00	286.00	251.00	6.35	800	155	267	1570





## OUR PRODUCT RANGE



## Fenner (India) Limited

**Corporate Office :** Khivraj Complex II, V Floor, 480, Anna Salai, Nandanam,  
Chennai-600 035 Tel: 24312450 to 57, Fax: 044 -24349016, 24320193.  
E.mail: ptd\_mhq@fennermail.com Website: www.fennerindia.com

**Registered Office:** 3, Madurai - Melakkal Road, Kochadai, Madurai - 625 016. Tel: 2383801, 2383802  
Fax : 0452 -2383822.

**Branches at :** **Ahmedabad :** Shreeji House, 3rd Floor, Behind M.J.Library, Ellis Bridge, Ahmedabad - 386 006. Tel: 079-26578572, 26578590. **Bangalore :** No.20, New Timber Yard Layout, Mysore Road, Bangalore - 560 026. Tel: 080-26756333, Fax : 080-26741001. **Indore:** 24, Sitabagh Colony, Dhenu Market, Indore - 452 001, Tel: 0731 -2538248. Fax: 0731-4043935 **Jaipur :** A-21, Opp. State Bank of India, Bais Godown, Industrial Area, Jaipur-302006, Tel:0141-2211075, 93148 70878. **Kanpur :** 112/371 (A), Swaroop Nagar, Kanpur - 208 002, Tel : 0512-2525304, 2540915, Fax: 0512-2294071. **Kochi :** 266-A & B, Temple Road, Koonamthai, Changampuzha Nagar, Kalamassery, Kochi-682033 Tel : 0484-3242480. **Kolkata :** 56-D, Mirza Ghalib Street, Kolkata-700 016. Tel : 033-22298784, 22298791 Fax : 033 -22290701, 22297880. **Ludhiana :** B-XVII/ 2820/48, Opp to Adam Park, Jammu Colony, Link Road, Ludhiana -141 003. Tel: 0161-2410214, Telefax:0161-2443791. **Madurai :** 117/6E, Madurai - Usilampatti Road, Meenakshipuram, Madurai-625 016. Tel : 0452-2383920, Telefax : 0452-2383921. **Mumbai :** 19/21, Manohardas Street, P.B. No.1307, Opp. G.P.O., Fort, Mumbai-400 001. Tel: 022-22695040, 22696329, 22697041, Fax: 022-22695199. **New Delhi :** 7th Floor, 'Hansalaya', 15, Barakhamba Road, New Delhi-110 001. Tel : 011-23314053, 23317016, 23314428, Fax : 011-23314429. **Secunderabad :** No.156/8, Plot No.147, A. P. Text Book Colony, Transport Road, Secunderabad -500 015 Tel : 040-27845443, 27845444.



All rights reserved by Fenner (India) Limited. No portion of the catalogue can be reproduced without authorisation of the copyright owner.